



Technical data

Voltage	U	120	V
Phase		1	~
Frequency		60	Hz
Speed		1650	RPM
Power consumption	P _e	170	W
Nominal current	I	1.7	A
Maximum current	I	0.0	A
Capacitor		12/250	μF
Ambient temperature	T _{amb min/max}	-13...104	°F
Insulation Class		CL.F	
IP Class		IP55	
Weight		21.3	Lbs.
Packing dimensions		19.7x19.7x11.4	inch



Control options

Triac controller	Yes
Transformer	Yes
Frequency drive	No

* All control options including single phase control frequency are available. Please contact Vostermans Ventilation Sales for more information

Fan details

Impeller blades	6
Impeller type	3
Impeller system	C
Impeller material	PP

Characteristics

0.00	in. wg	2150	CFM
0.20	in. wa	1850	CFM

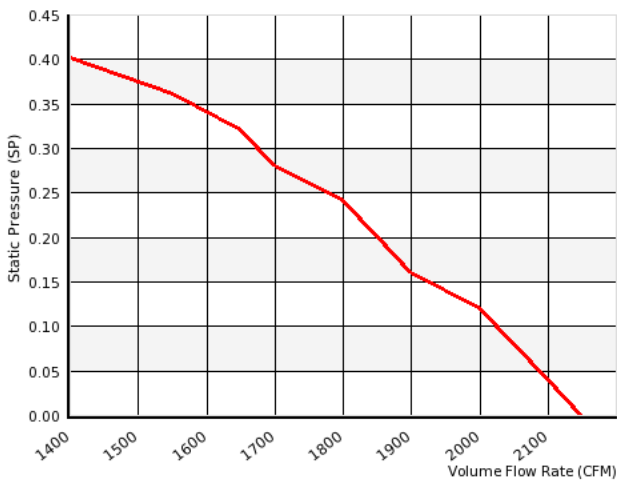

Approval(s)



Wiring diagram

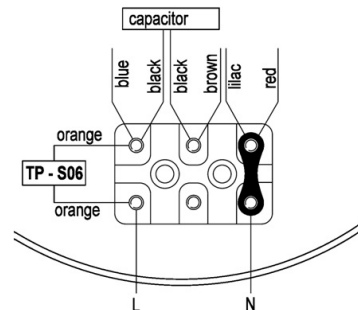

Dimensions

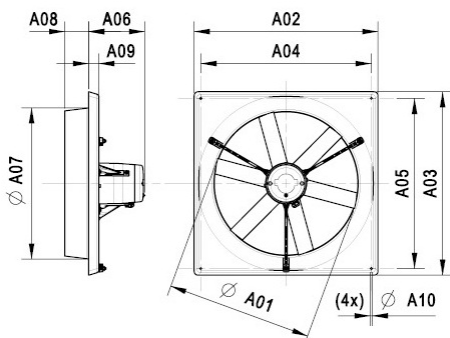

A01	14.3 inch
A02	19.4 inch
A03	19.4 inch
A04	17.5 inch
A05	17.5 inch
A06	7.6 inch
A07	15.4 inch
A08	3.3 inch
A09	1.4 inch
A10	0.3 inch