

# SNAP-FAN INSTALLATION

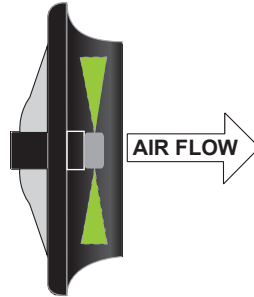

Only a qualified and licensed electrician or contractor should install or service Snap-Fan products. If someone other than a licensed electrician installs a Snap-Fan, Snap-Fan disclaims all warranties for the product, and specifically disclaims any warranty for consequential damages.

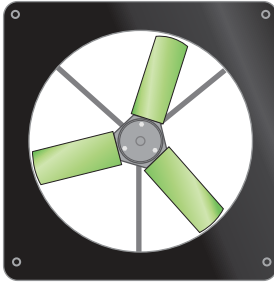

## Proper Placement

Be sure to place the fan in a suitable location to maximize air movement. Typically Snap-Fans are installed close to room's ceiling to both exchange and circulate warm interior air with cool air from outside. The air intake opening should be placed at a low spot on the opposite end of the structure, bringing cool air across it.

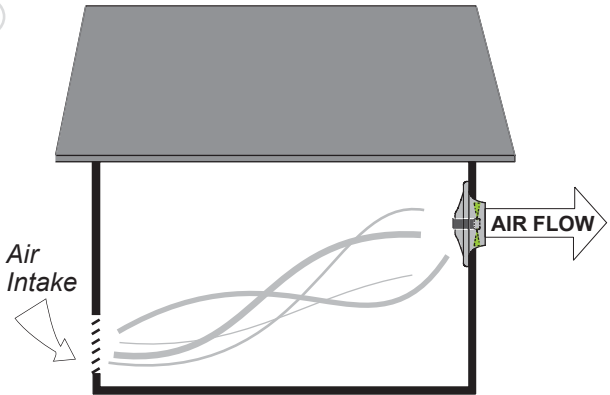

We recommended the surface area of your air intake to be 1.5 times the surface area of the exhausted air (size of opening on fan).

## The Elements

Shelter your Snap-Fan from inclement weather and natural hazards such as, not limited to; wind, water, rain, hail, dust, ice, snow and nesting birds. If you do not plan on using your Snap-Fan during wet winter months please remove it and store in a dry location. Long periods of moisture shortens the life span of the motor. Snap-Fan must not be placed in harsh fertilizer environments.

## Safety Information



All applicable electrical safety precautions and building codes must be adhered to and followed when installing this product.



Occupational Safety and Health Administration (OSHA) requires finger guards at locations under eight feet from the floor.



Refer to installation and operation manuals before installing, servicing or operating this unit.



DO NOT CUT AWAY ANY FRAMING FROM THE ORIGINAL STRUCTURE, AS IT MAY EFFECT LOAD BEARING CAPACITY.

# INSTALLING SNAP-FAN

---

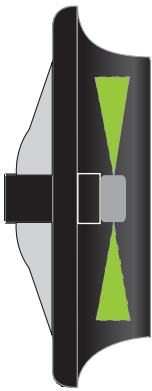
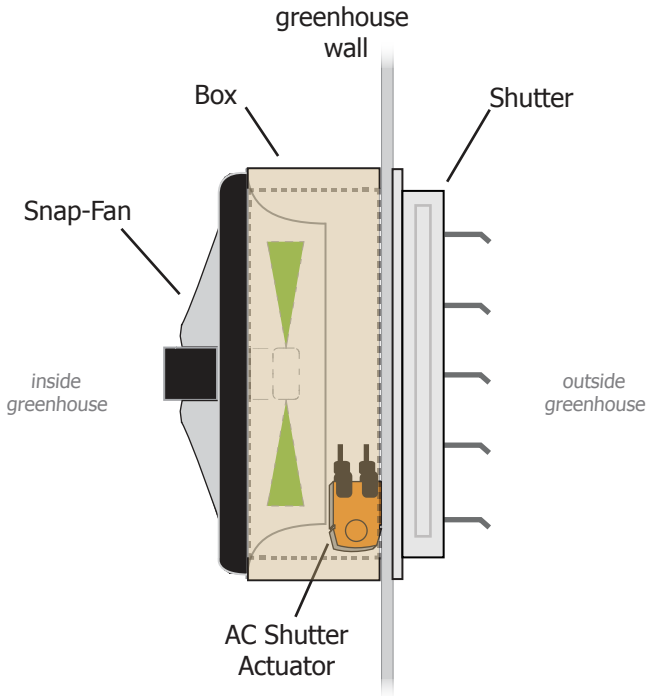

Snap-Fan



Box



Shutter Actuator

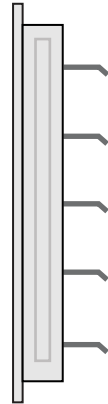

Shutter

**1**

Choose a location to install your Snap-Fan(s).

Exhausting hot air from the highest point possible is recommended.

Measure the distance between the two up-rights on the end wall of the greenhouse. Or locate a cross member at a suitable height to act as a shelf to mount your bottom-plate onto.

Center and side support posts will need to be added and connected to the bottom-plate to hold the weight of the fan system.

We recommend using 4x4's.

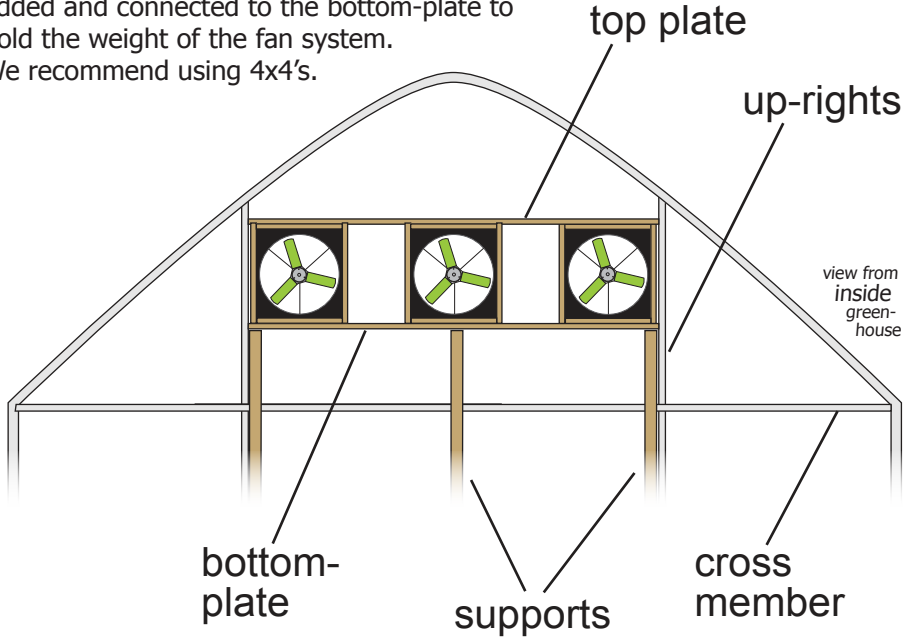
**2**

Build a square box for each fan to be mounted in.

See page 8-9 for box dimensions

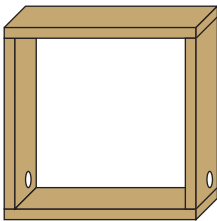

\*optional with automated shutter

If installing shutter with shutter actuator:

When framing 12", 16" or 20" fan:  
use 2x6 lumber (1.5" x 5.5")

When framing 24" or 28" fan:  
use 2x8 lumber (1.5" x 7.5")

\*If installing shutter actuator: Drill hole on one side to allow wiring of the actuator and fan to go through. If installing multiple fans, consider drilling holes on both sides to allow the wires to run through multiple boxes.

3

From inside, secure the bottom-plate to metal framing of the greenhouse.  
(a) Connect the bottom-plate to the up-rights using L brackets.

The front edge of the bottom-plate must be flush to the inside of the greenhouse wall.

a.

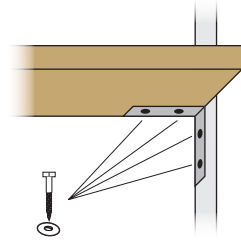

view from  
inside  
greenhouse

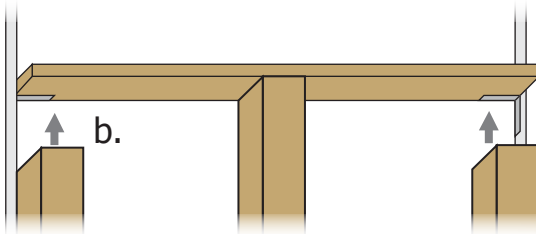

(b) Add the center and side supports to the bottom-plate.

(c) If a cross member is already in place you have the option of connecting the shelf to the greenhouse frame using saddle clamps, if it can sit flush with the inside of the greenhouse wall..

**Be sure to still provide the support posts.**

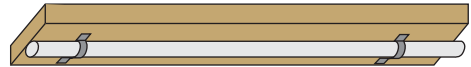

4

Securely attach each box to the bottom-plate, making sure they are evenly spaced. Once all boxes have been mounted, the top of each box must be secured to the greenhouse framing:

option a:

Create and attach a top-plate to finish out the framing. Connect top-plate to up-rights using L brackets.

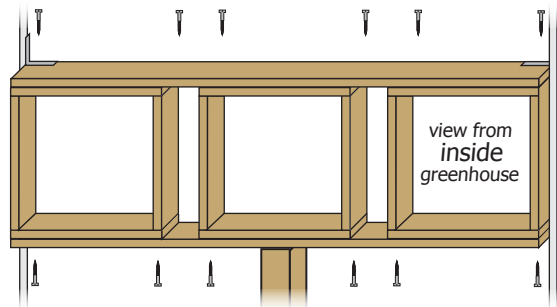

option b:

If a cross member is already in place you have the option of connecting the top of the frame to the cross member using saddle clamps.

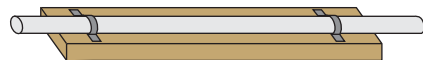

5

Mount each fan onto its corresponding box on the inside of the greenhouse using recommended 1/2" x 4" hex head lag screw and washer.

**If installing automated shutter skip step 5 and see instructions on bottom of this page.**

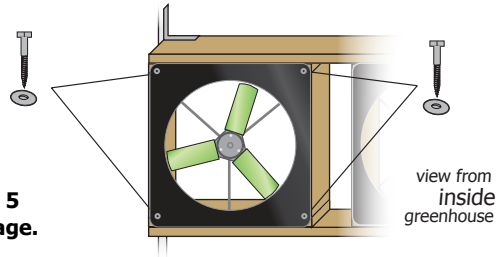

See below the 3 outside wall options: *view from outside greenhouse*

Round opening with battening plastic not recommended

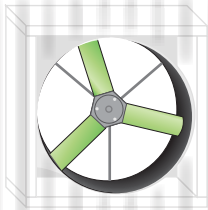

Shutter #1 recommended

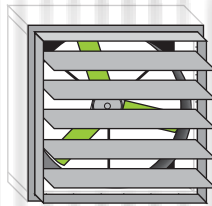

Rain hood #2 recommended

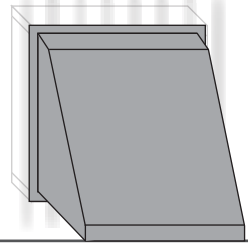

6

Cut out opening in the greenhouse wall: (from the outside of the greenhouse)

(a) staple or finish nail the greenhouse siding to the wooden box all the way around.

(b) Remove the greenhouse siding to allow air movement. Cut/saw just inside of the box.

\*You have the option to cut around the end of the bell curve (opening) of the fan instead of a square. This is recommended if you are not adding a shutter or rain hood.

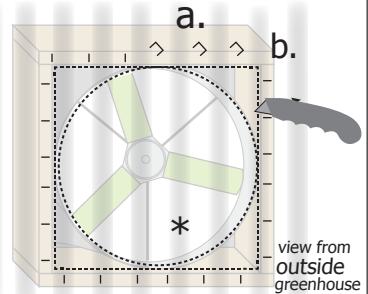

**Shutter:**

Install shutter to the wooden box from the outside of the greenhouse. The greenhouse siding will be sandwiched between box and shutter. See shutter install instructions included in shutter packaging.

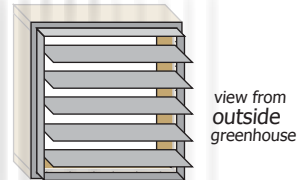

**Shutter Actuator:**

Connect shutter to shutter actuator. If you ordered an automated shutter see shutter actuator install instructions included in actuator packaging for details on connecting and wiring. **You will need to mount fan after installing shutter and shutter actuator.**

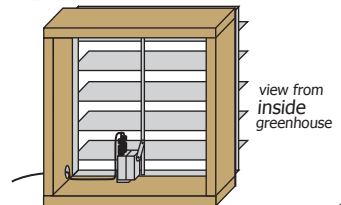

# DC FAN WIRING

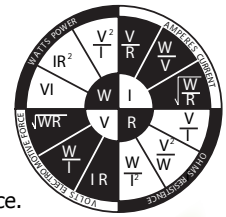

Only qualified personnel should install or perform maintenance on Snap-Fan and Snap-Fan motor.

## OHM'S LAW

The law that for any circuit the electric current is directly proportional to the voltage and is inversely proportional to the resistance.

### USER SUPPLIED SOLAR PANEL \*

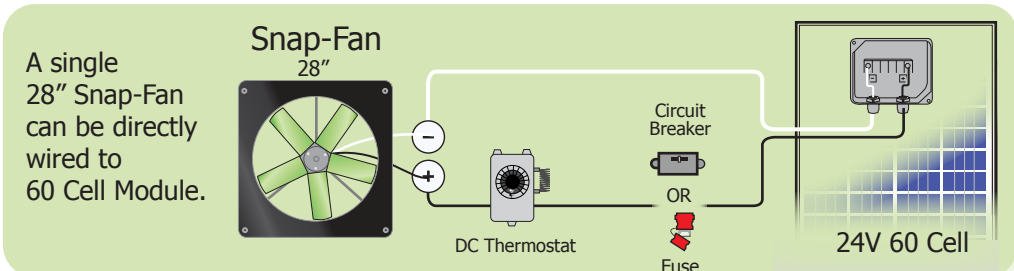
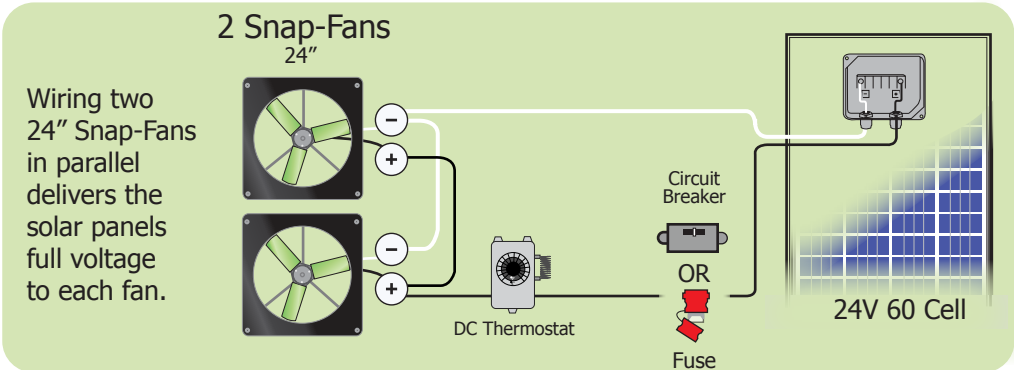
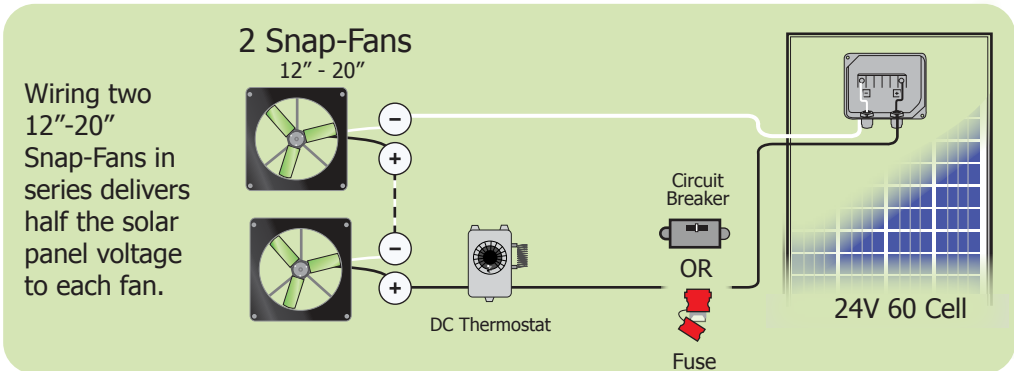
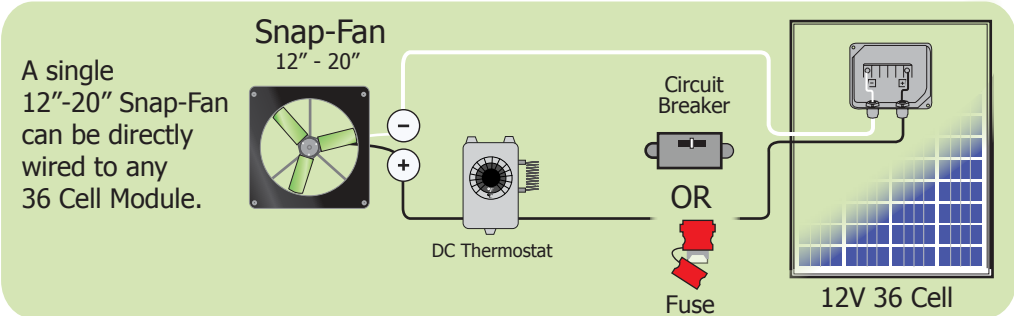

# AC FAN WIRING



Only qualified personnel should install or perform maintenance on Snap-Fan, Snap-Fan controllers and Snap-Fan motor.

## SINGLE SPEED

Once fan has been installed, plug into grounded 120 AC outlet. Fan will run at factory programmed speed when powered. Use a thermostat, switch or timer to control operation.

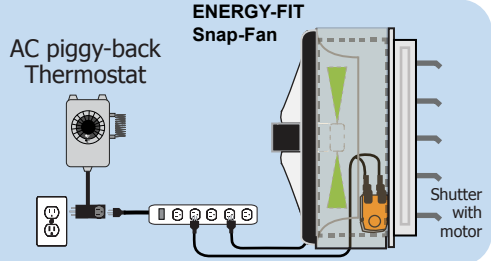

## VARIABLE SPEED

### WITH TEMPERATURE CONTROL ADDITION

\* If you ordered an Energy-Fit Variable Speed system, please see wiring instructions included in product packaging (sold separately). Connect a thermostat to automate fan speed based on temperature (sold separately).

### 1-16 Energy-Fit Fan speed control configuration

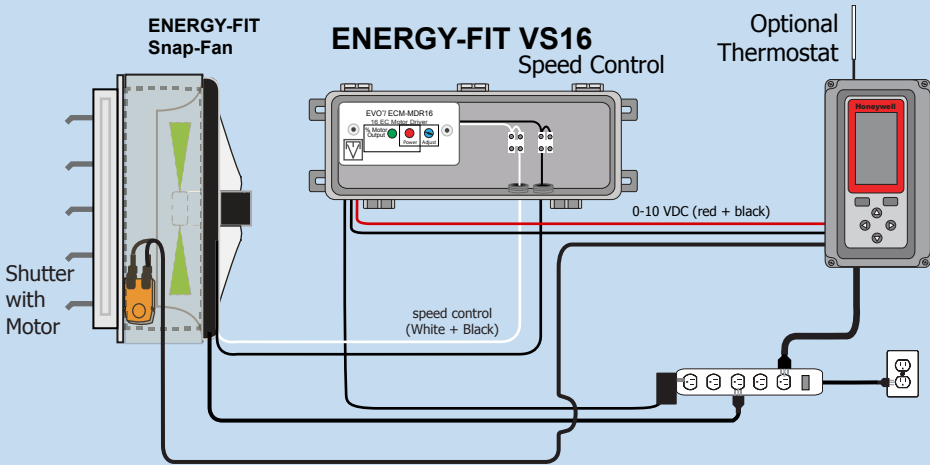

**Energy-Fit VS16 will control up to 16 VS AC Snap-Fans.**

## AC SOLAR DIRECT DRIVE

Connect AC fan to DC power supply by connecting to micro inverter. See wiring instructions online at [snap-fan.com](http://snap-fan.com)

# FAN MOUNTING BOX DIMENSIONS

Use this guide to determine the dimensions of the box necessary to mount your Snap-Fan with the Automated Shutter (shutter with actuator). Applications vary by system design. If you are installing fan into a building, visit [snap-fan.com](http://snap-fan.com) for hole diameter sizes.

## 12" SNAP-FAN

DC part#: 1200  
AC part#: 1259

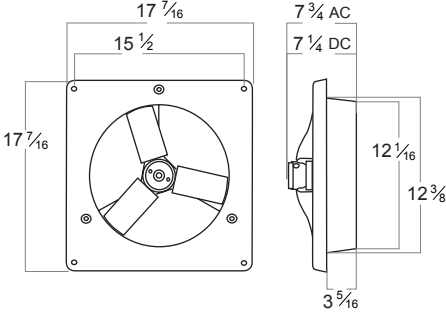

Mounting Box

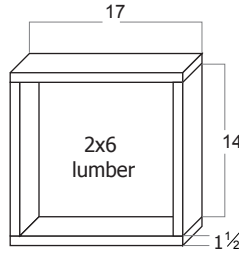

12" Snap-Fan SHUTTER  
part#: 6900

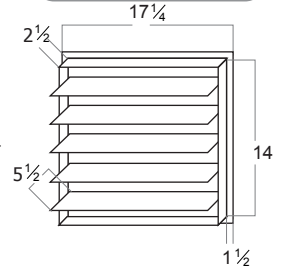

## 16" SNAP-FAN

DC part#: 1600  
AC part#: 1659

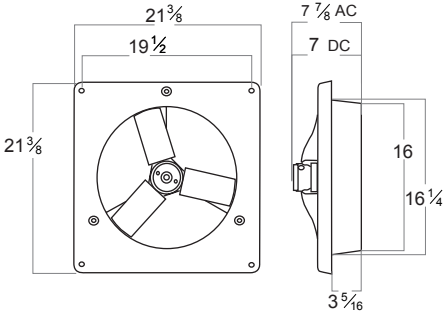

Mounting Box

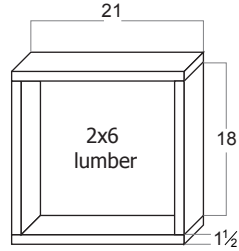

16" Snap-Fan SHUTTER  
part#: 6904

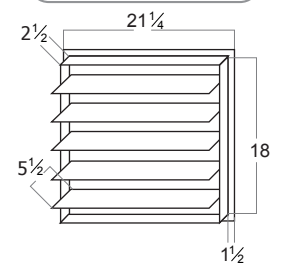

## 20" SNAP-FAN

DC part#: 2000  
AC part#: 2059

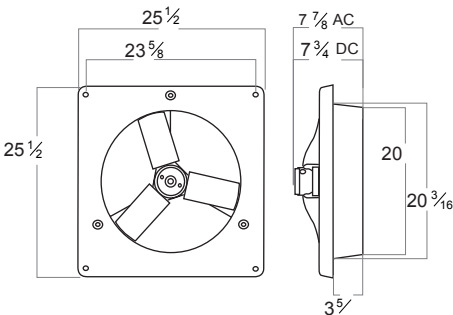

Mounting Box

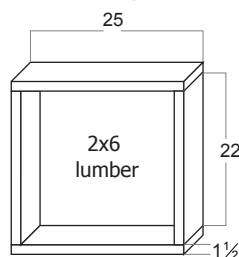

20" Snap-Fan SHUTTER  
part#: 6905

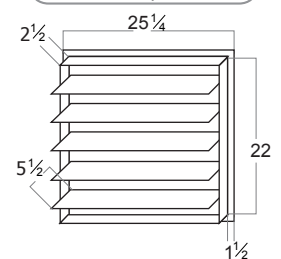



### 24" SNAP-FAN

DC part#: 2400  
AC part#: 2459

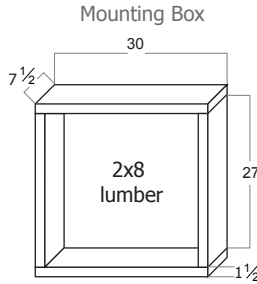
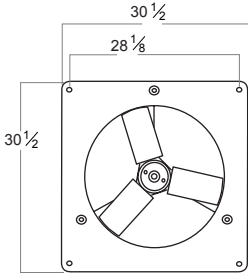

### 24" Snap-Fan SHUTTER part#: 6906

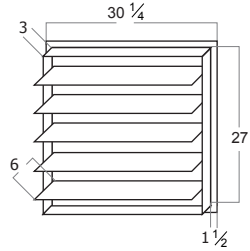

### 28" SNAP-FAN

DC part#: 2800  
AC part#: 2859

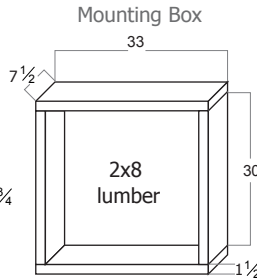
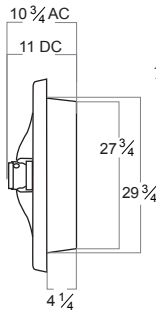
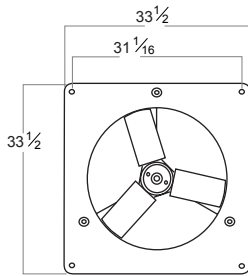

### 28" Snap-Fan SHUTTER part#: 6901

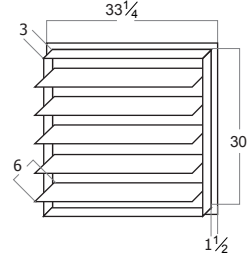

### 50" SNAP-FAN

DC only W/ Automated Shutter and Thermostat  
part#: 5000

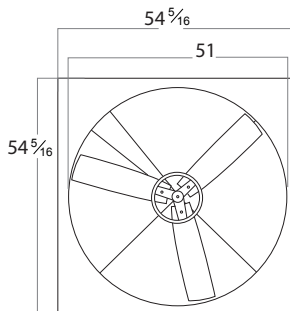
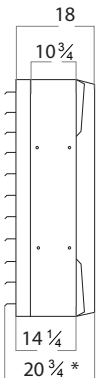

\*with shutter open

### Shutter Controls

Automated  
Shutter Motor  
for 12"-28" Fan



**SHUTTER MOTOR**  
AC only  
part#: 6912

Automated  
Shutter Motor  
for 50" Fan



**SHUTTER MOTOR**  
DC only  
part#: 6910

If you ordered a 50 inch Snap-Fan, see installation instruction sheet attached to product.

# BRUSH REPLACEMENT INSTRUCTIONS

For 12", 16", 20" and 24" DC Snap-Fan.

 Only a qualified and licensed electrician or contractor should install or service Snap-Fan products. If someone other than a licensed electrician installs a Snap-Fan, Snap-Fan disclaims all warranties for the product, and specifically disclaims any warranty for consequential damages. All applicable electrical safety precautions must be adhered to and followed when servicing this product.

**Disconnect from power supply before servicing motor.**

All DC Snap-Fans have a Brush motor. Brush wear is normal. Brushes will need to be replaced after extended use depending on size of fan and amount of use per season. Fan slowing and/or inconsistent operation generally indicates that it is time to replace the brushes.

12" and 16"  
Snap-Fan

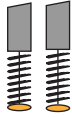

Part# 1314

20" Snap-Fan

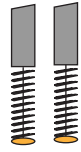

Part# 2014

24" Snap-Fan

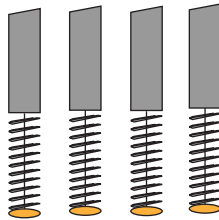

Part# 2415

28" Snap-Fan  
requires motor disassembly

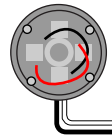

Brush Assembly  
Part# 2814

OR

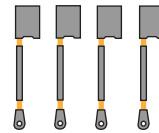

Individual (4)  
Part# 2815

## 1 Disconnect fan from power supply:

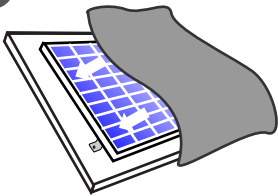

Cover solar panel with blanket or black plastic.

The solar panel produces electricity when exposed to light.

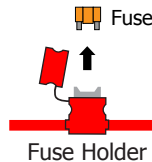

Remove fuse from fuse holder

## 2

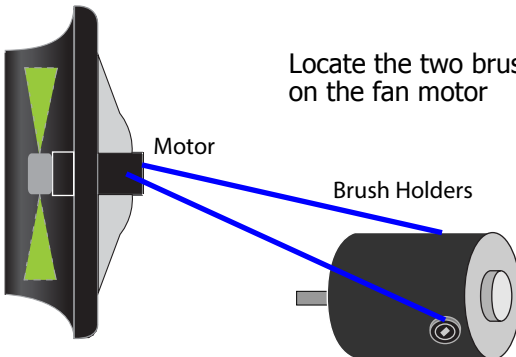

Locate the two brush holders on the fan motor

3

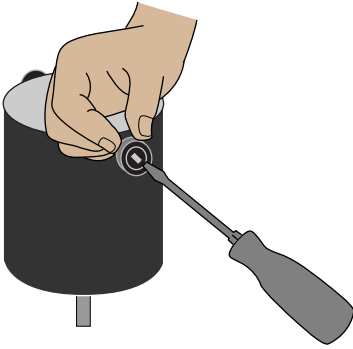

Remove cap of brush holder with a flat head screw driver. Hold brush holder in place to ensure it does not twist while removing cap.

Brush Holder Cap



4

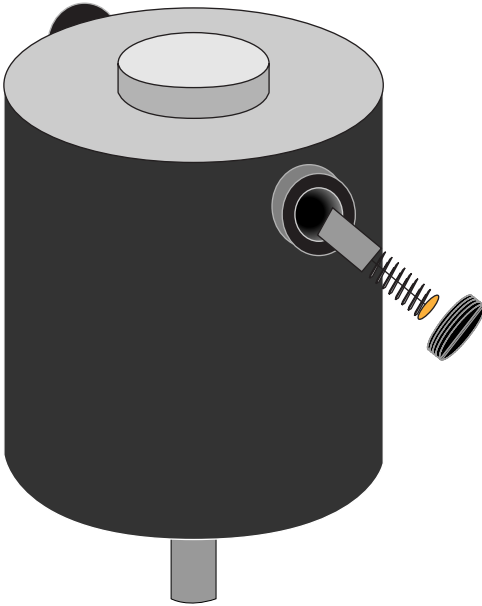

Remove worn brushes and replace with new brushes.

\*Brush holders are very fragile. When replacing brushes, take care not to over tighten the brush holder cap.

Fasten cap back onto brush holder.

Repeat with second brush on opposite side of motor.

### Reconnect fan to power supply:

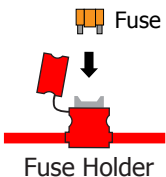

Insert fuse back into fuse holder

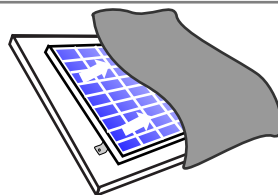

Remove cover from solar panel.

# Product Support & Contact Information

Snap-Fans are high efficiency ventilation fans designed to be used in ventilation applications. Using this equipment for any other purpose or in a manner not consistent with the operating recommendations within this manual will void the warranty and may cause personal injury.

## Solar National Air Propulsion



Snap-Fan, LLC  
PO Box 4461  
Arcata, CA 95518  
707-822-6727

For claims, please contact your retailer directly or email us at: [support@snap-fan.com](mailto:support@snap-fan.com)  
Visit [snap-fan.com](http://snap-fan.com) for replacement parts

### **RETAIL RETURN POLICY** Only applicable if you ordered directly from Snap-Fan, LLC.

The goal of Snap-Fan, LLC, is that its customers be completely satisfied with their purchase. If you are not completely satisfied, you have 30 days from the date of purchase to return the product. Please first contact Snap-Fan to obtain authorization for the return and then return the product to Snap-Fan. Upon receipt, the purchase price will be refunded so long as the product and its packaging is in merchantable condition. No returns will be accepted for products that are not in a merchantable condition, although if only the packaging is damaged, Snap-Fan will accept the return and charge a 10 percent repackaging fee. No returns will be accepted without prior authorization and all shipping costs are the sole responsibility of the purchaser. No returns will be accepted for products purchased from somewhere other than directly from Snap-Fan – any such returns should be made to that location and made in conformance with that location's own return policy, (if any). Finally, no returns will be accepted for custom made or special order items. If you have any questions about this policy, please contact us.

### LIMITED WARRANTY

**WARRANTY AND DISCLAIMER:** Snap-Fan, LLC, extends this limited warranty to the original purchaser (the "Purchaser") and warrants that products supplied by Snap-Fan shall be free from original defects in workmanship and materials for **two years** from date of shipment, provided those Products have been properly handled, stored, installed, serviced, maintained and operated. This warranty shall not apply to products which have been **improperly installed, altered or repaired** without the Snap-Fan's express authorization, or altered or repaired in any way so as, in the Snap-Fan's judgment, to affect its performance or reliability or subjected to misuse, negligence, or accident, or incorrectly used in combination with other products. **Improper installation** specifically includes, but is not limited to: (1) the use of the Product in an environment where it is exposed to nominal voltage in excess of 24 volts DC, or in the case of an AC Product, in excess of the voltage specified on the Product ("overvoltage"); (2) use or storage in a setting where the Product is exposed to inclement weather. Any damage that Snap-Fan determines, in its sole discretion, as resulting from misuse shall not be covered by any warranty.

**LIMITATION OF REMEDY AND DAMAGES:** All claims under this warranty must be first made by telephone to Snap-Fan at 707-822-SNAP, within 15 days after discovery of the defect and prior to the expiration of two years from the date of shipment by the Company of the product claimed defective, and Purchaser shall be barred from any remedy if Purchaser fails to make such claim within such period.

Within 30 days after receipt of a timely claim, Snap-Fan will authorize the Purchaser to return the product to Snap-Fan at Purchaser's sole expense for inspection by Snap-Fan. Following such inspection, Snap-Fan will replace, or at its option repair, free of charge, any product it determines to be defective, and it shall ship the repaired or replacement product to Purchaser F.O.B. point of shipment; provided, however, if circumstances are such that as in Snap-Fan's sole judgment repair or replacement is impractical or that the repair or replacement would result in further warranty work due to the particular use of the Product, the Purchaser's sole and exclusive remedy shall be a refund to the Purchaser of any part of the invoice price paid to Snap-Fan for the defective Product or part.

Under no circumstances shall Snap-Fan be responsible for the cost of removal of the defective Product or part, damages due to removal, or any expenses incurred in shipping the Product or part to or from Snap-Fan, or the installation of the repaired or replaced Product or part. The warranties set forth above do not apply to any components, accessories, parts or attachments manufactured by other manufacturers; such being subject to that manufacturer's warranty, if any. To the extent not prohibited by that manufacturer's warranty, Snap-Fan shall pass through to Purchaser such manufacturer's warranty.

**THIS WARRANTY IS IN LIEU OF ALL OTHER WARRANTIES, EXPRESS OR IMPLIED, ARISING BY LAW OR OTHERWISE, INCLUDING WITHOUT LIMITATION THE IMPLIED WARRANTIES OF MERCHANTABILITY AND FITNESS FOR A PARTICULAR PURPOSE, WHICH ARE HEREBY EXPRESSLY DISCLAIMED AND WAIVED. THIS WARRANTY CONSTITUTES SNAP-FAN'S SOLE AND EXCLUSIVE WARRANTY FOR DEFECTIVE GOODS AND PURCHASER'S SOLE AND EXCLUSIVE REMEDY FOR DEFECTIVE PRODUCTS.**

No employee, agent, dealer, or other person is authorized to give any warranties on behalf of Snap-Fan or to assume for Snap-Fan any other liability in connection with any of its products except in writing and signed by an officer of Snap-Fan.

**TECHNICAL ADVICE AND RECOMMENDATIONS, DISCLAIMER:** Notwithstanding any past practice or dealings or any custom of the trade, sales shall not include the furnishing of technical advice or assistance or system design. Any such assistance shall be at Snap-Fan's sole option and may be subject to additional charge.

Snap-Fan assumes no obligation or liability on account of any recommendations, opinions or advice as to the choice, installation or use of products. Any such recommendations, opinions or advice are given and shall be accepted at Purchaser's sole risk and shall not constitute any warranty or guarantee of such Products, their performance, or their suitability for any particular purpose.

**LIMITATION OF LIABILITY:** The cumulative liability of Snap-Fan to the Purchaser and any other persons for all claims in any way relating to or arising out of the Products, including, but not limited to, any cause of action sounding in contract, tort, or strict liability, shall not exceed the total amount of the purchase price paid for those Products which are the subject of any such claim. This limitation of liability is intended to apply without regard to whether other provisions of this agreement have been breached or have proven ineffective even if Snap-Fan has been advised of the possibility of such claims or demands. In no event shall Snap-Fan be liable to the Purchaser or any other person for any loss of profits or any incidental, special, exemplary, or consequential damages for any claims or demands brought by the Purchaser or such other persons.

**INDEMNITY:** Snap-Fan's maximum liability to Purchaser and to any other user is as set forth above. Snap-Fan makes no warranty to anyone for any products not manufactured by it and shall have no liability for any use or installation of any Products (whether manufactured by Snap-Fan or other manufacturers) not specifically authorized by this sale. Purchaser acknowledges various warnings by Snap-Fan regarding the products and its installation and use and acknowledges that the Product should only be installed by a competently trained and licensed electrician or contractor. If Snap-Fan incurs any claims, lawsuits, settlements, or expenses (including attorney fees) for any loss, injury, death or property damage including, but not limited to, claims arising out of the Purchaser's or any end user's installation or use of the products, the Purchaser shall indemnify and hold Snap-Fan harmless unless such injury, death, or property damage unless such was the result of Snap-Fan's sole negligence or willful misconduct.